

ELEVATION 04

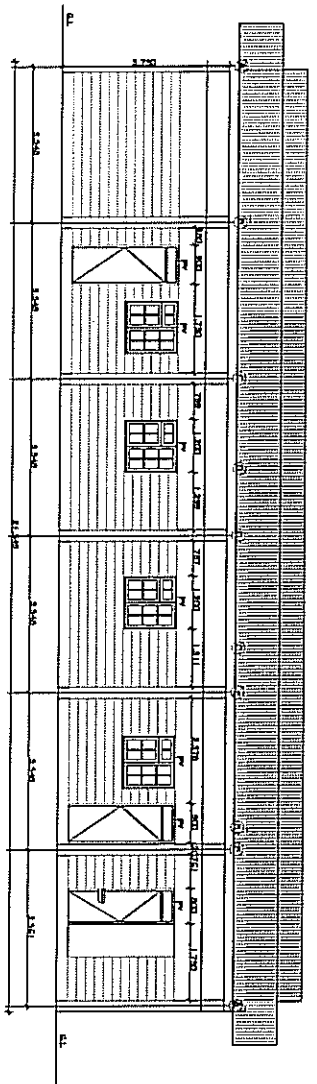

ELEVATION 03

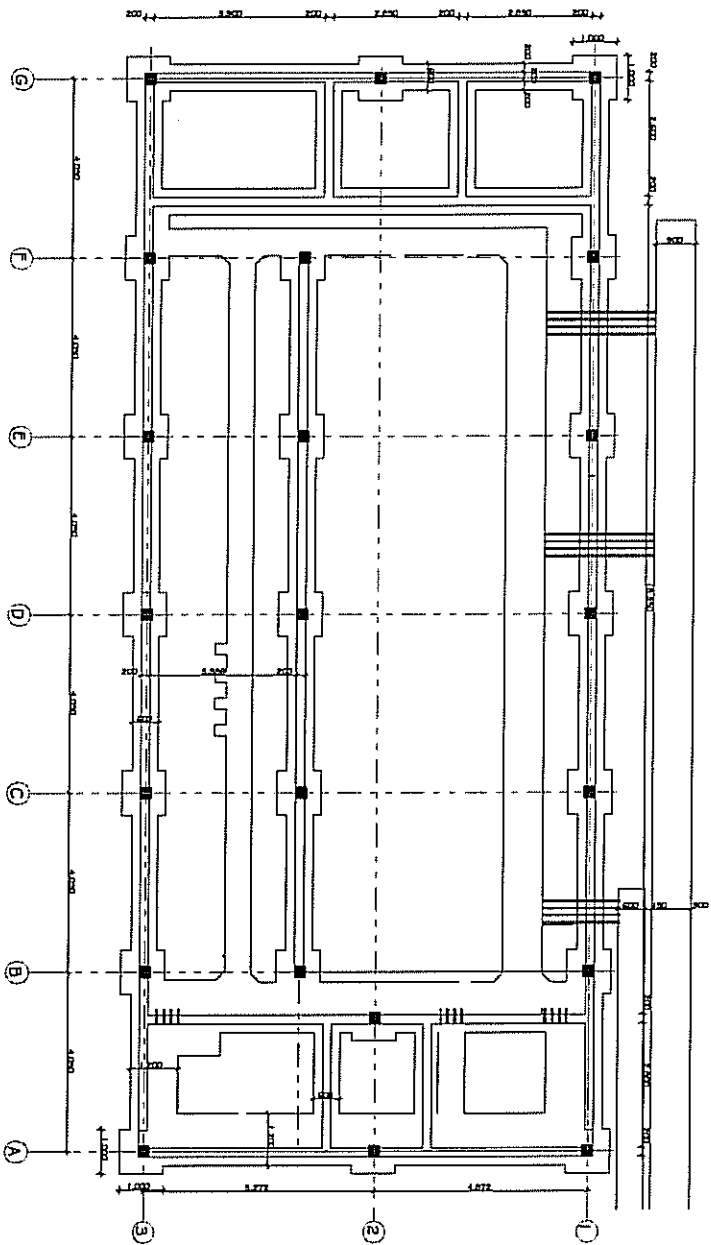

FOUNDATION FLOOR PLAN

APPROVED	SCALE	DATE	REVISION

NO.	REVISION	DATE	BY	CHECKED	DATE
1					
2					
3					
4					
5					
6					
7					
8					
9					

**DETAILS OF 11KV. CONTROL ROOM FOR UPTO 16 PANELS
(FROM 7.5 MVA TX INDOOR S/STN)**

SCALE 1:50

SHEET 1A/1

K.P.&L.Co.Ltd

S.K. No. 08280/B

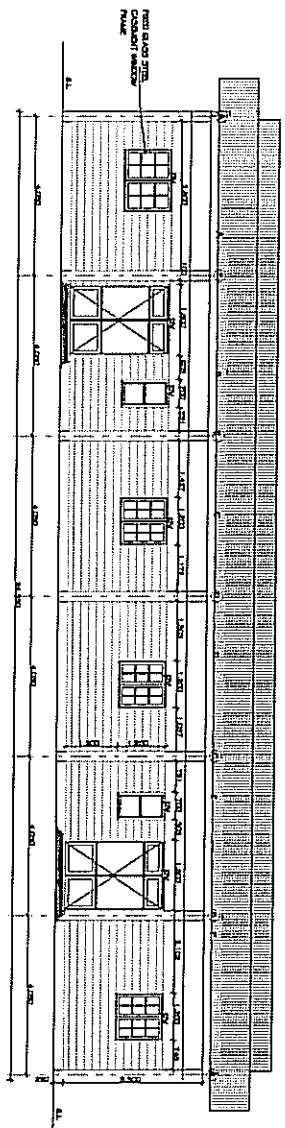

ELEVATION 01

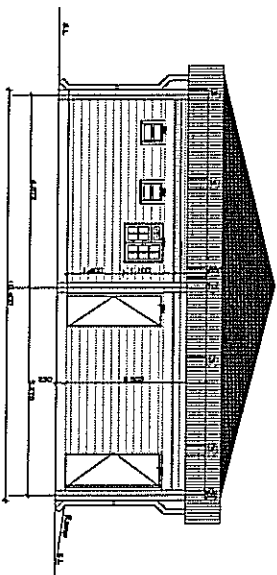

ELEVATION 02

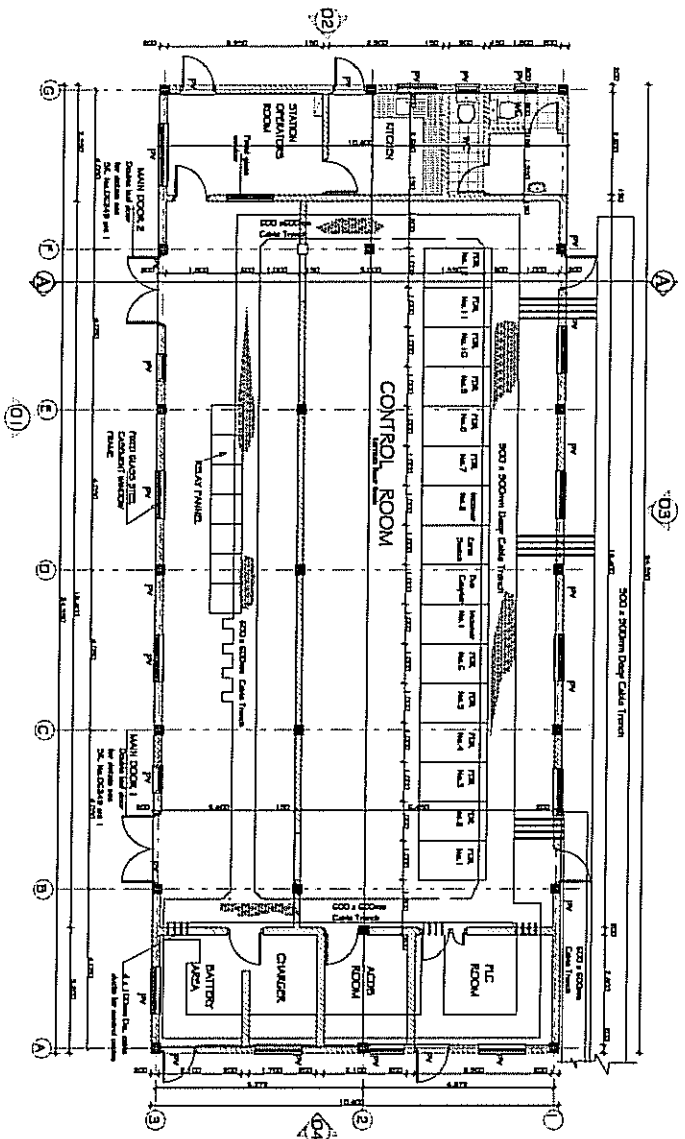

GROUND FLOOR PLAN

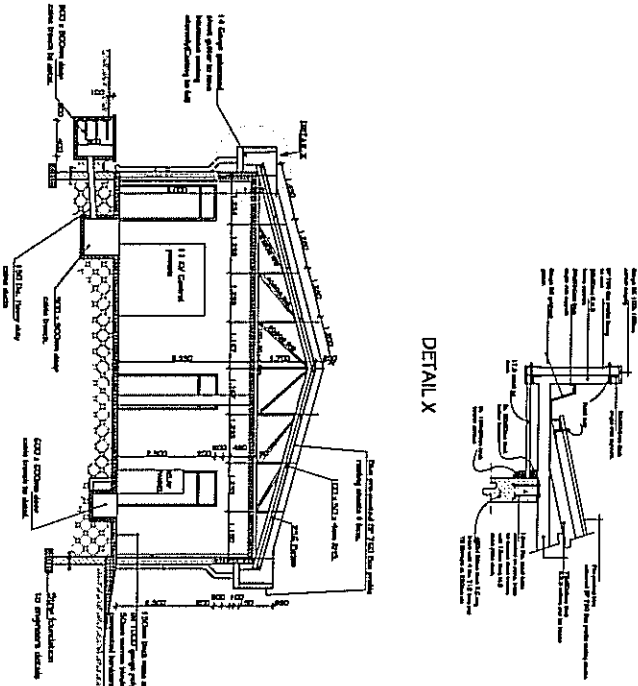

SECTION A - A

DETAIL X

NO.	DATE	REVISION	BY	CHKD
1	15/01/80	ISSUED FOR TENDERS		
2	15/01/80	REVISED DRAWING		
3	15/01/80	REVISED DRAWING		
4	15/01/80	REVISED DRAWING		
5	15/01/80	REVISED DRAWING		
6	15/01/80	REVISED DRAWING		
7	15/01/80	REVISED DRAWING		
8	15/01/80	REVISED DRAWING		
9	15/01/80	REVISED DRAWING		
10	15/01/80	REVISED DRAWING		

DETAILS OF 11KV. CONTROL ROOM FOR UPTO 16 PANNELLS
(FROM 7.5 MVA TX INDOOR S/STN)

SCALE 1:100

SHEET 1A

K.P.A.L. Co Ltd

SK. No. 08280/B

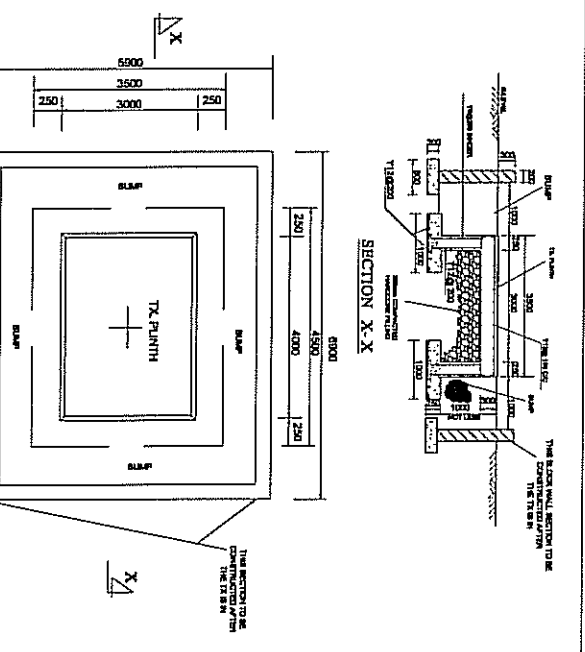
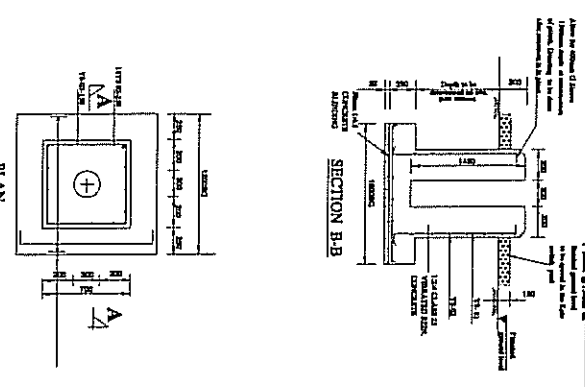
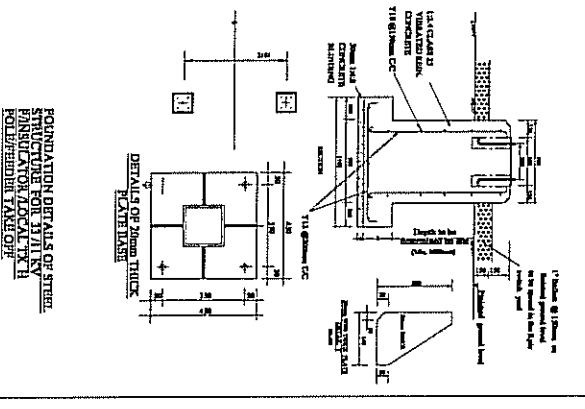
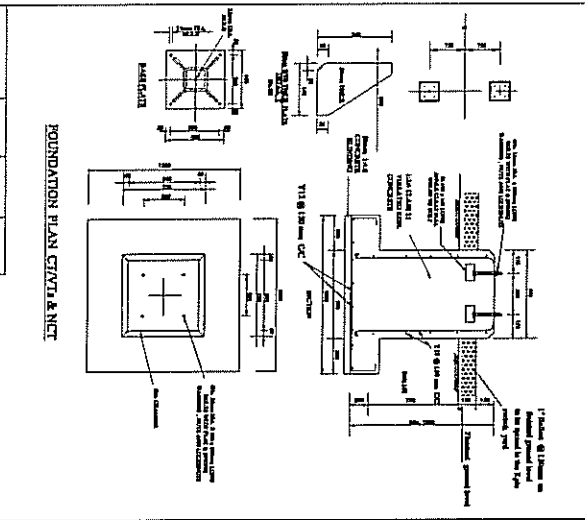
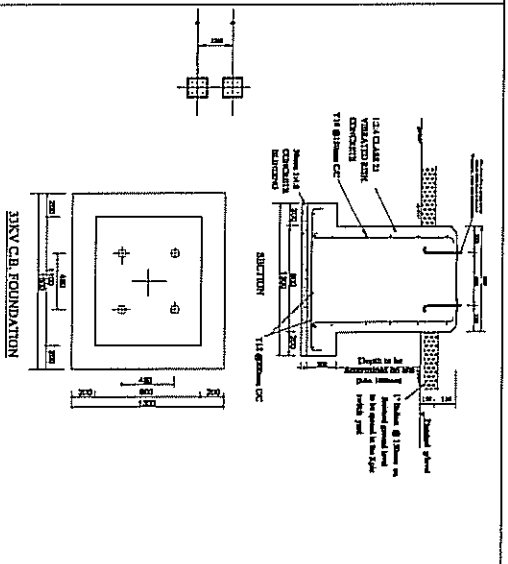
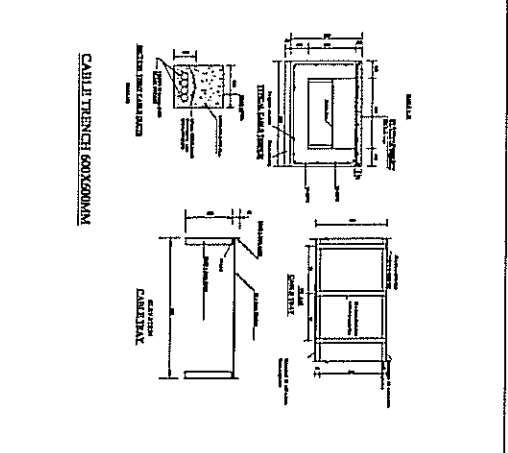
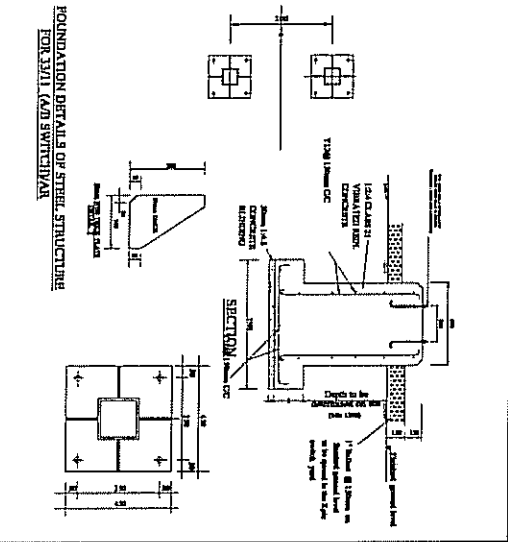
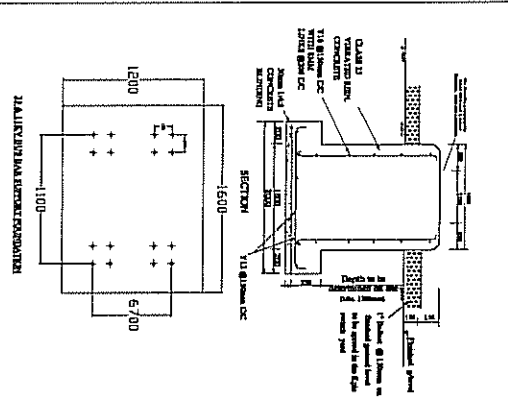

REV	DATE	BY	CHKD	DESCRIPTION
1	20/01/11
2
3
4
5
6
7
8
9
10
11
12
13
14
15
16
17
18
19
20
21
22
23
24
25
26
27
28
29
30
31
32
33
34
35
36
37
38
39
40
41
42
43
44
45
46
47
48
49
50
51
52
53
54
55
56
57
58
59
60
61
62
63
64
65
66
67
68
69
70
71
72
73
74
75
76
77
78
79
80
81
82
83
84
85
86
87
88
89
90
91
92
93
94
95
96
97
98
99
100

FOUNDATION DETAILS FOR TYPICAL 33 / 11 KV SUBSTATION CIVIL WORKS

K. P. & L. Co. Ltd.

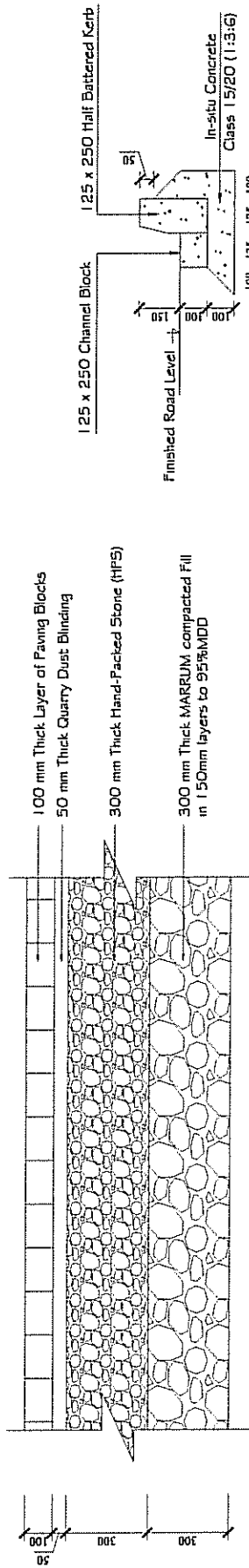

ROAD SECTION DETAIL
(Scale 1:25)

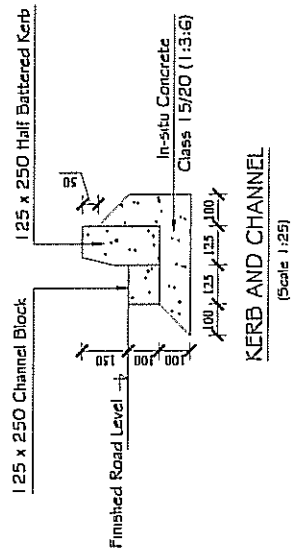

KERB AND CHANNEL
(Scale 1:25)

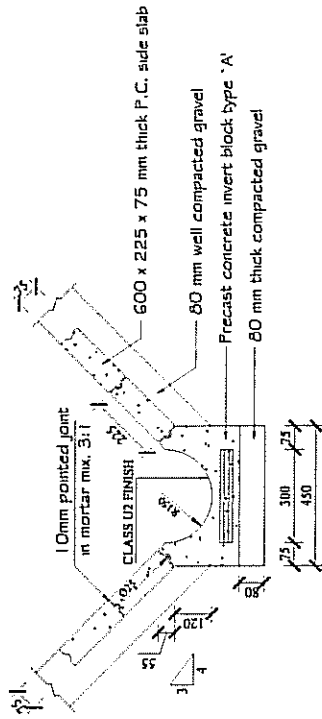

END ELEVATION

SIDE ELEVATION

INVERT BLOCK DRAIN TYPE 'A' ASSEMBLY DETAIL
(Scale 1:25)

APPROVED	NAME	DATE	SCOPE
DESIGNED	D. JAYASINGHE		
CHECKED	D. JAYASINGHE		
DRAWN	D. JAYASINGHE		
DATE			
NO.			
REV.			

DATE	NO.	REVISION	DATE

CIVIL WORKS DETAILS SUBSTATION
SCALE: 1:100

SHEET 2A

K.P. & L. Co. LTD.

SK. No. 05821
Kanga Puvet

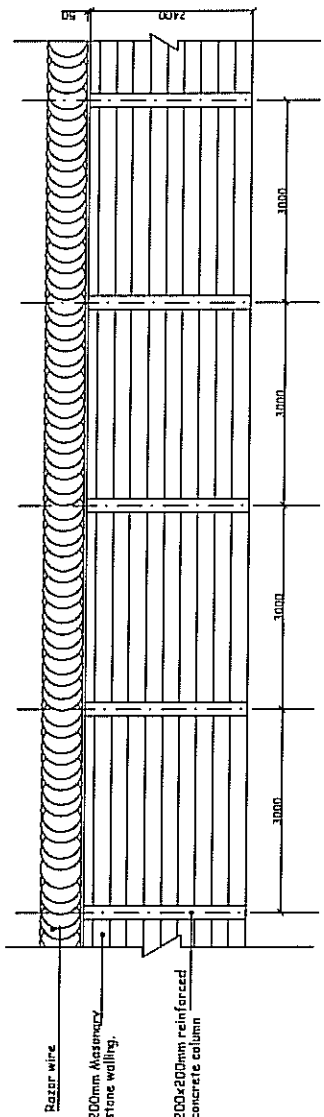

FRONT VIEW

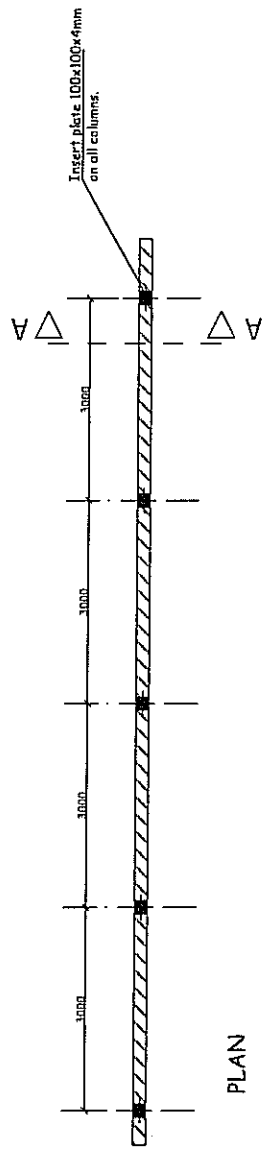

PLAN

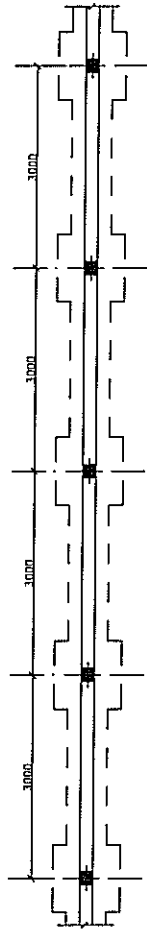

FOUNDATION PLAN

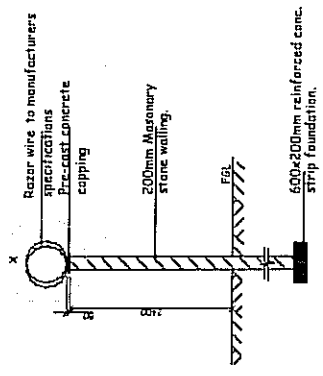

SECTION A - A

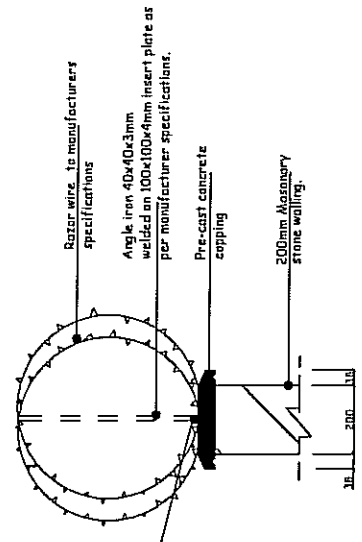

DETAIL X

APPROVED	DATE	BY

DETAILS OF SECURITY FENCE AT PRIMARY SUB - STATION

SCALE 1 : 50

SHEET 1A

K.P.&L.Co.Ltd

SK. No. 07044/B

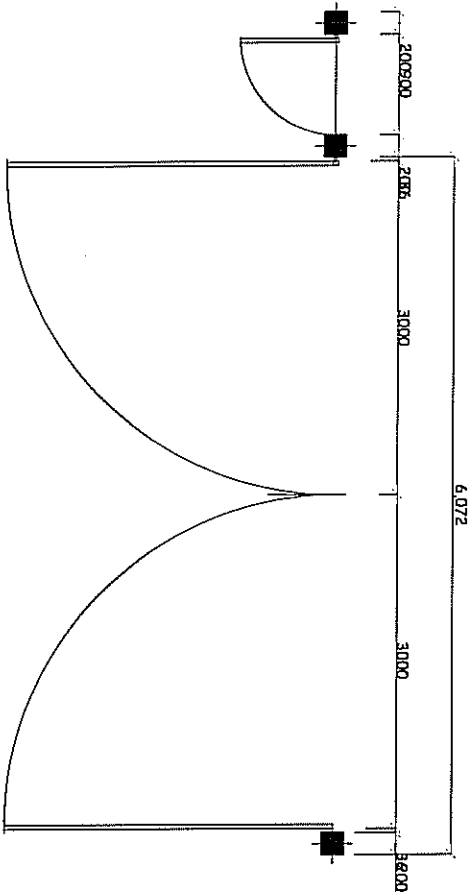
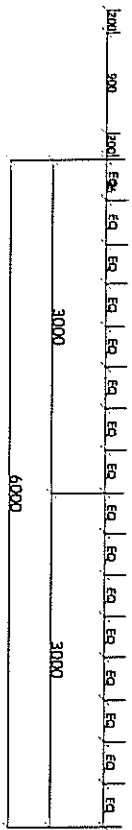
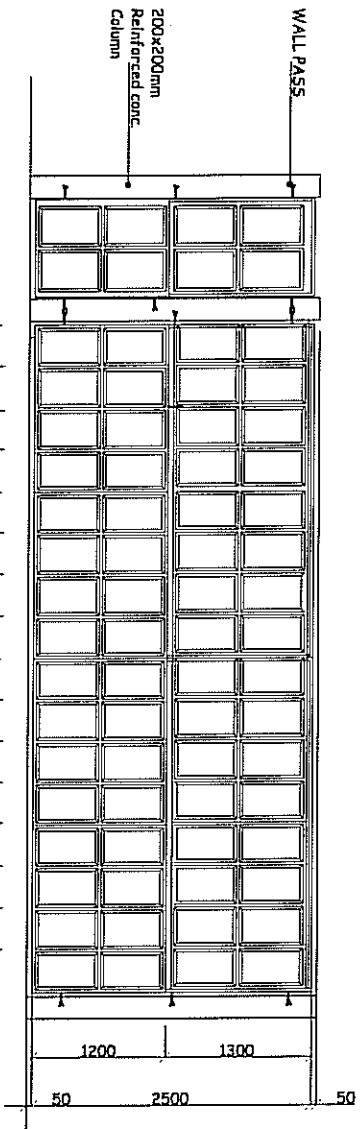

APPENDIX			
REVISION	DATE	BY	REASON
1			
2			
3			
4			
5			
6			
7			
8			
9			
10			

DETAIL PRIMARY SUBSTATION SOLID PANEL GATE

SHT 3

K. P. & L. Co. Ltd.

SK. NO. 07044/B

OIL SUMP DETAILS

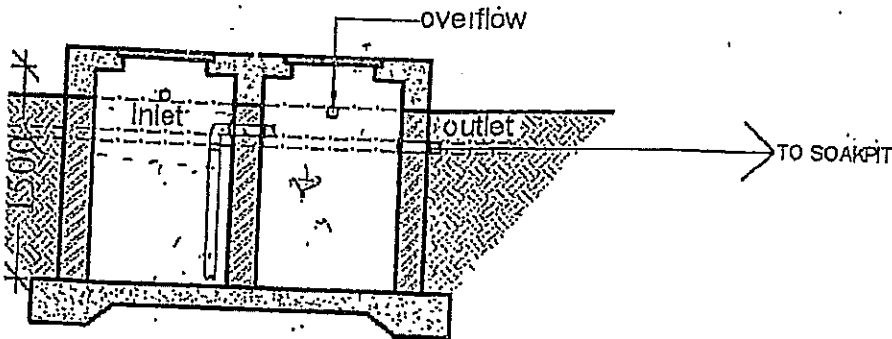

section

OIL INTERCEPTOR

